

PHILIPS

AMBILIGHT tv

Quick Start Guide

OLED850/OLED860 Series

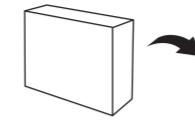

Tool needed for assembly

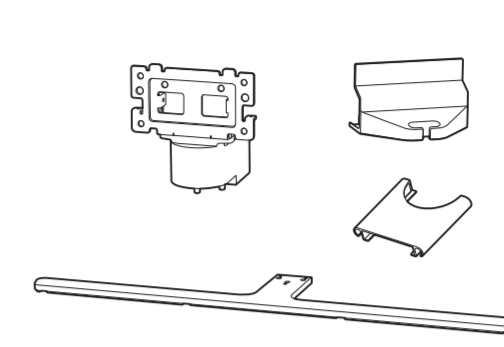
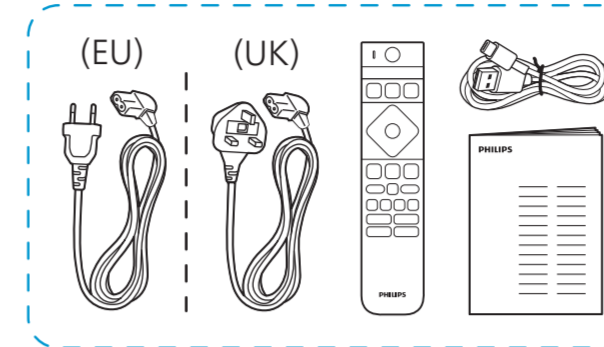
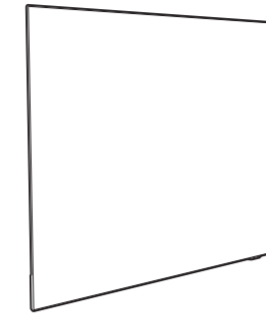

55"/65"
(M5xL14) : X4
55"/65"
(M5xL14) : X3



1 55"

65"

2

3

A Desk Placement

B Wall Placement

A

Recommended Wall Distance

10-20 cm

4 **Get Connected**

www.philips.to/smartTV

The Philips Smart TV app lets you switch channels and adjust the volume - just like a remote control.

5 **Register and Support**

www.philips.com/TVsupport

Register your TV, find out more, download the user manual and get support

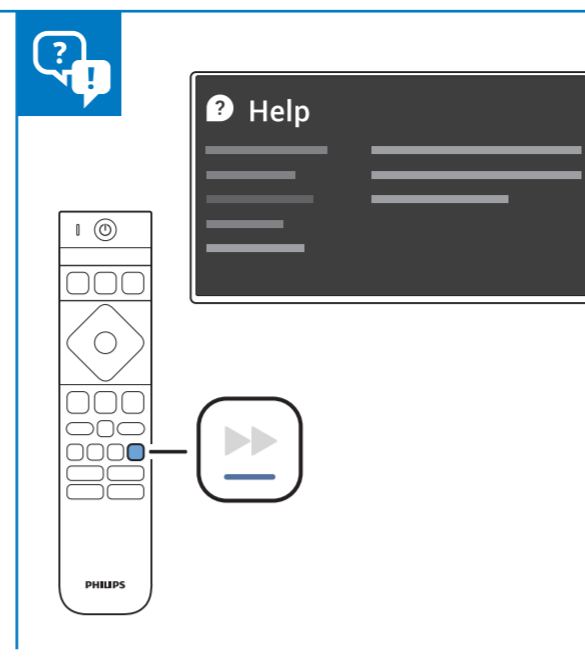
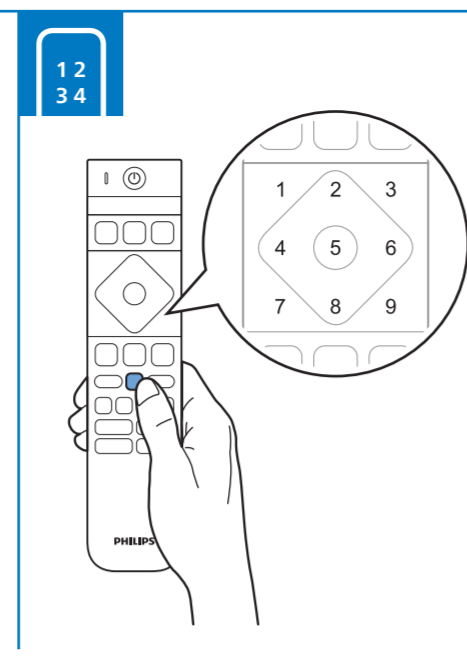
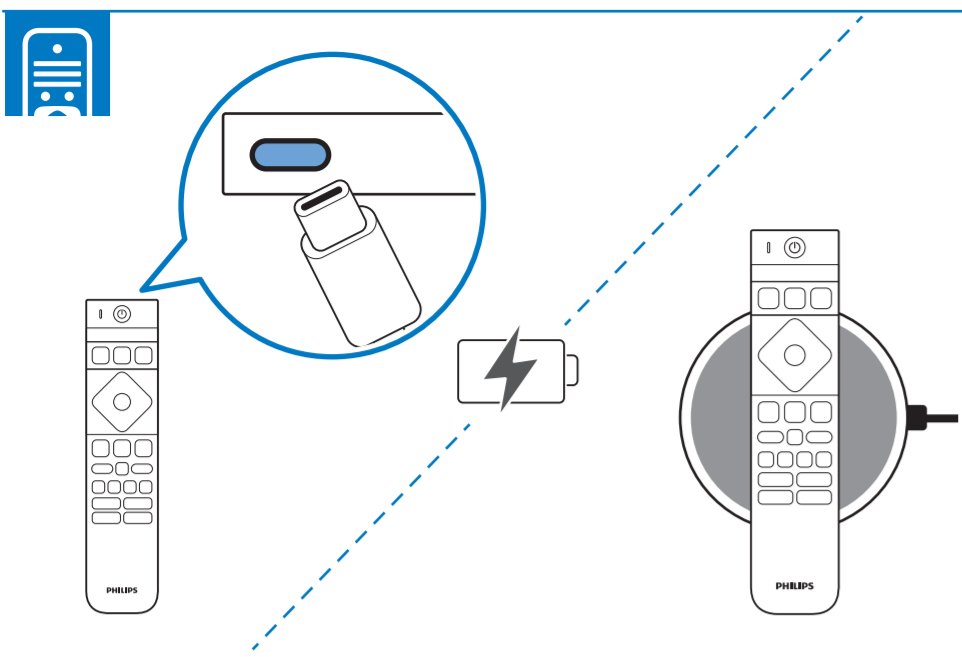

English Read the safety instructions.

Български Прочетете инструкциите за безопасност.

Čeština Přečtěte si bezpečnostní pokyny.

Hrvatski Pročitajte sigurnosne upute.

Dansk Læs sikkerhedsforskrifterne.

Deutsch Lesen Sie die Sicherheitshinweise.

Ελληνικά Διαβάστε τις οδηγίες ασφαλείας.

Eesti Lugege ohutusnõudeid.

Español Lea las instrucciones de seguridad.

Français Lisez les consignes de sécurité.

Italiano Leggere le istruzioni di sicurezza.

Қазақша Қорғаныстық нұсқаулар.

Latviešu Izlasiet drošības norādījumus.

Lietuvių Perskaitykite saugos instrukcijas.

Magyar Olvassa el a biztonsági utasításokat.

Nederlands Lees de veiligheidsvoorschriften.

Norsk Les sikkerhetsforskriftene.

Polski Zapoznaj się z instrukcjami bezpieczeństwa.

Português Leia as instruções de segurança.

Română Citiți instrucțiunile de siguranță.

Русский Читайте инструкции по технике безопасности.

Srpski Pročitajte bezbednosna uputstva.

Slovenščina Preberite varnostna navodila.

Slovenský Prečítajte si bezpečnostné pokyny.

Suomi Lue turvaohjeet.

Svenska Läs säkerhetsinstruktionerna.

ภาษาไทย โปรดอ่านคำแนะนำด้านความปลอดภัย

Türkçe Güvenlik talimatlarını okuyun.

Українська Читайте інструкції з техніки безпеки.

العربية قراءة تعليمات السلامة.

עברית קראו את הוראות הבטיחות

FSC Logo H:12mm

FEUILLE Séparer les éléments avant de briser

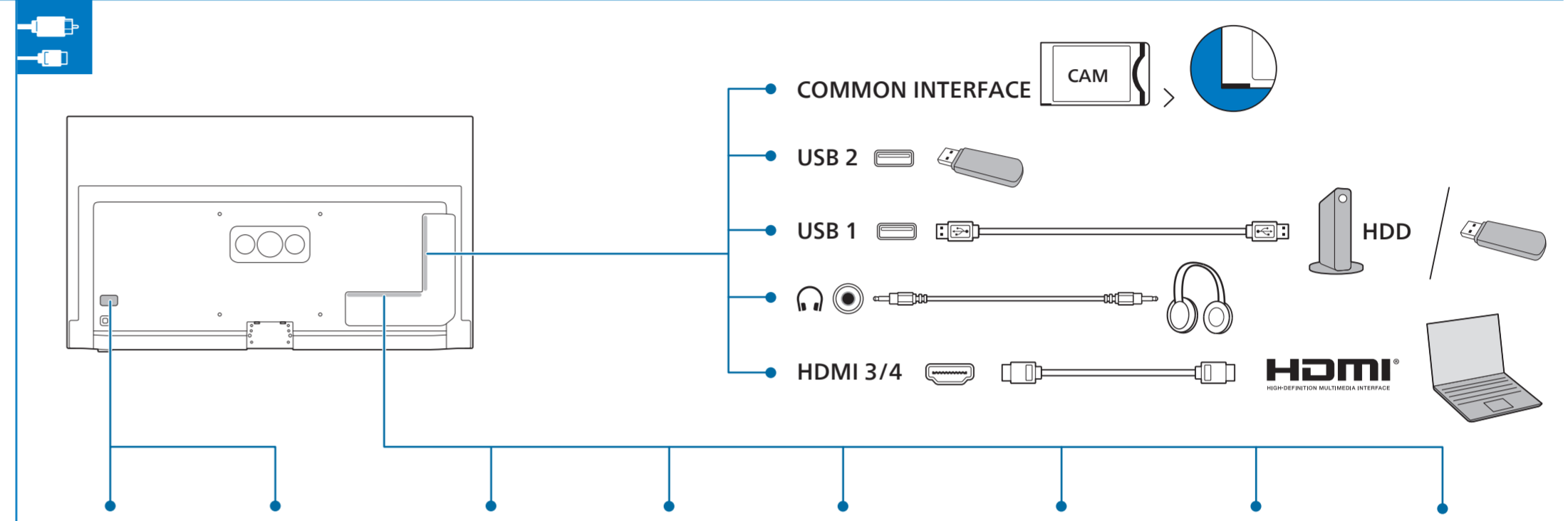
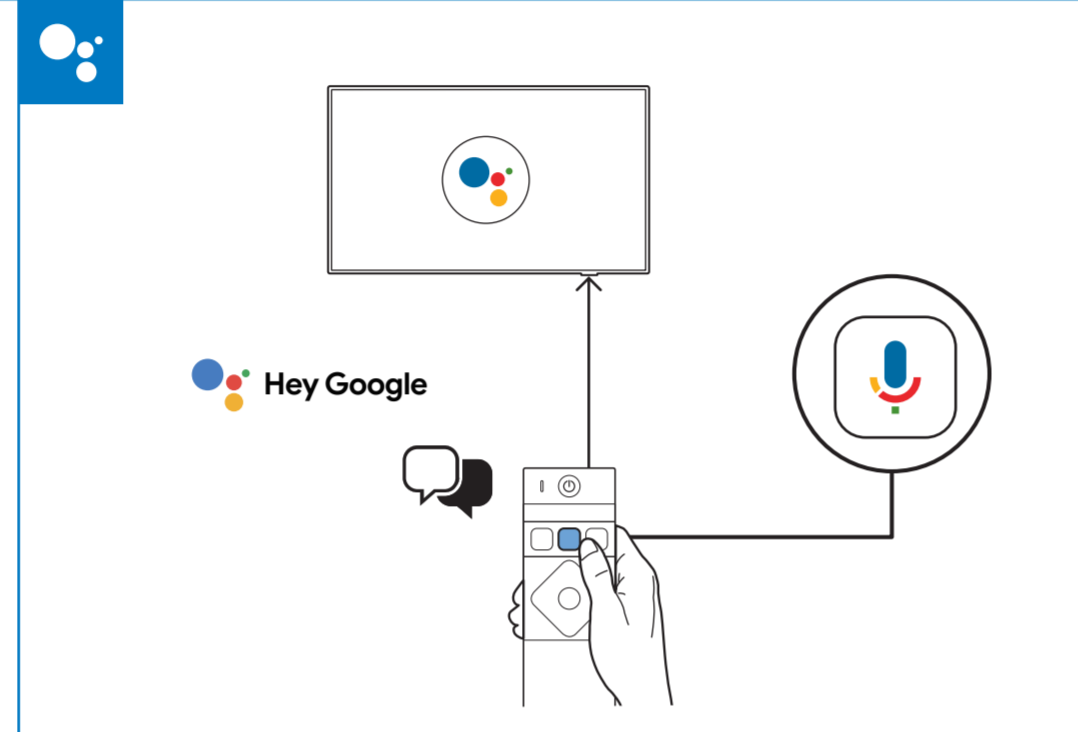
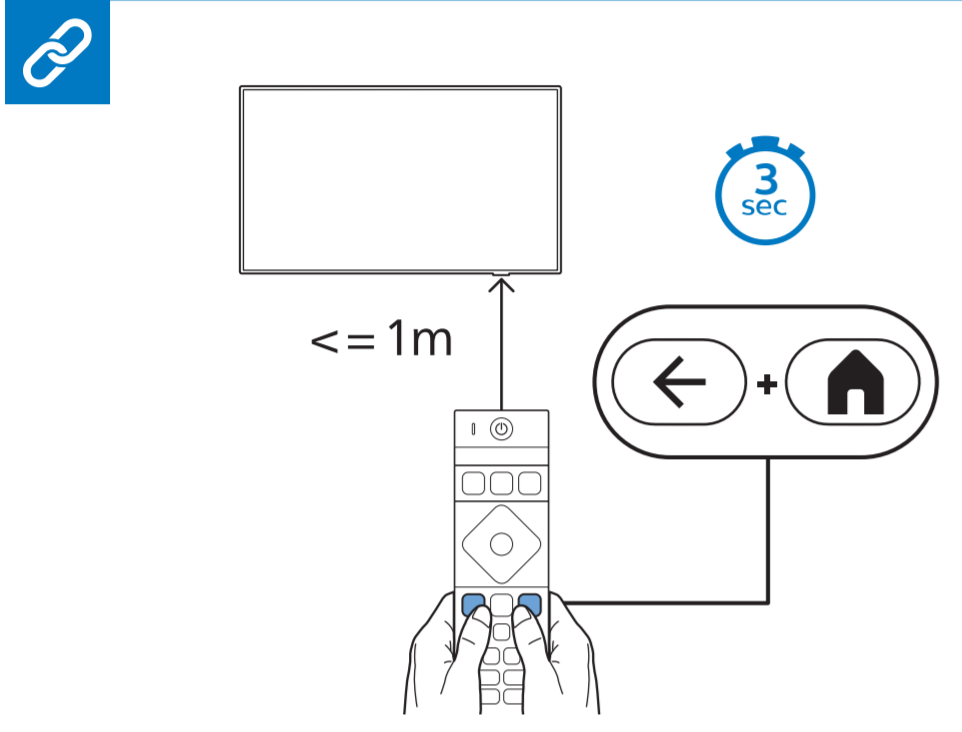

B

1

2

Diagonal (inch/cm)	X (mm)	Y (mm)	Screw Size	Screw Length (mm)
55" / 139	300	300	M6	10-15
65" / 164	300	300	M6	10-15

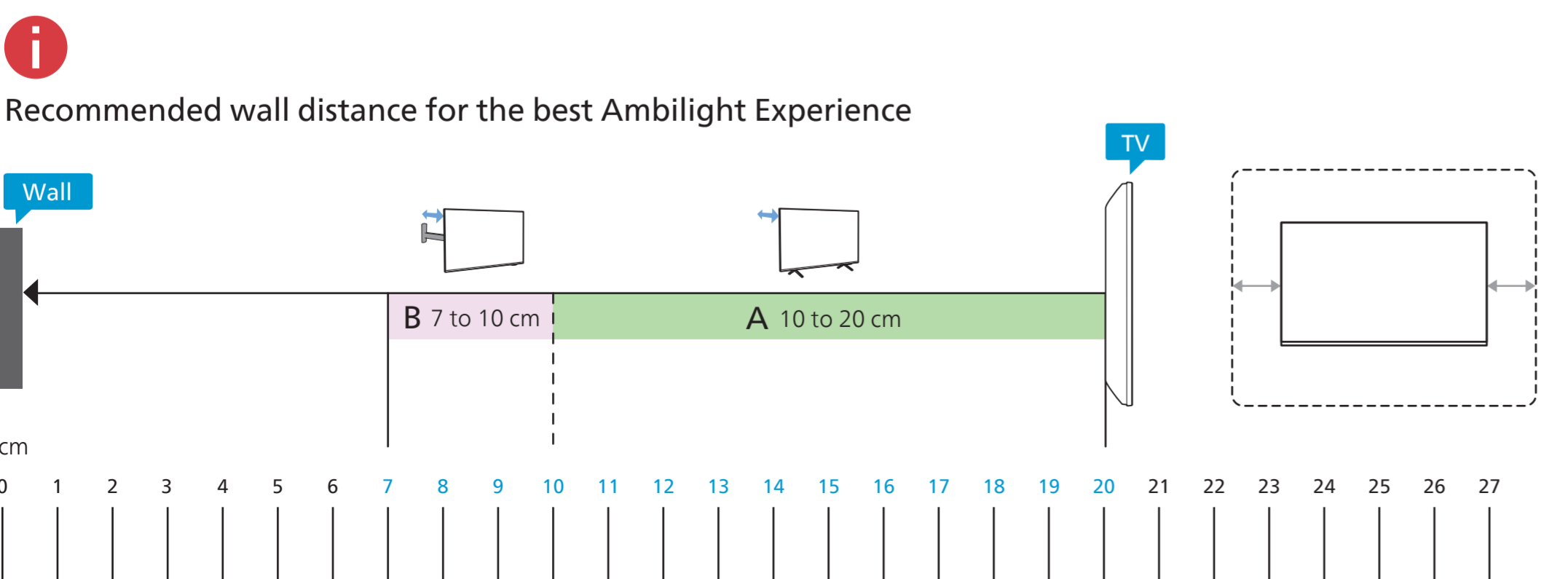
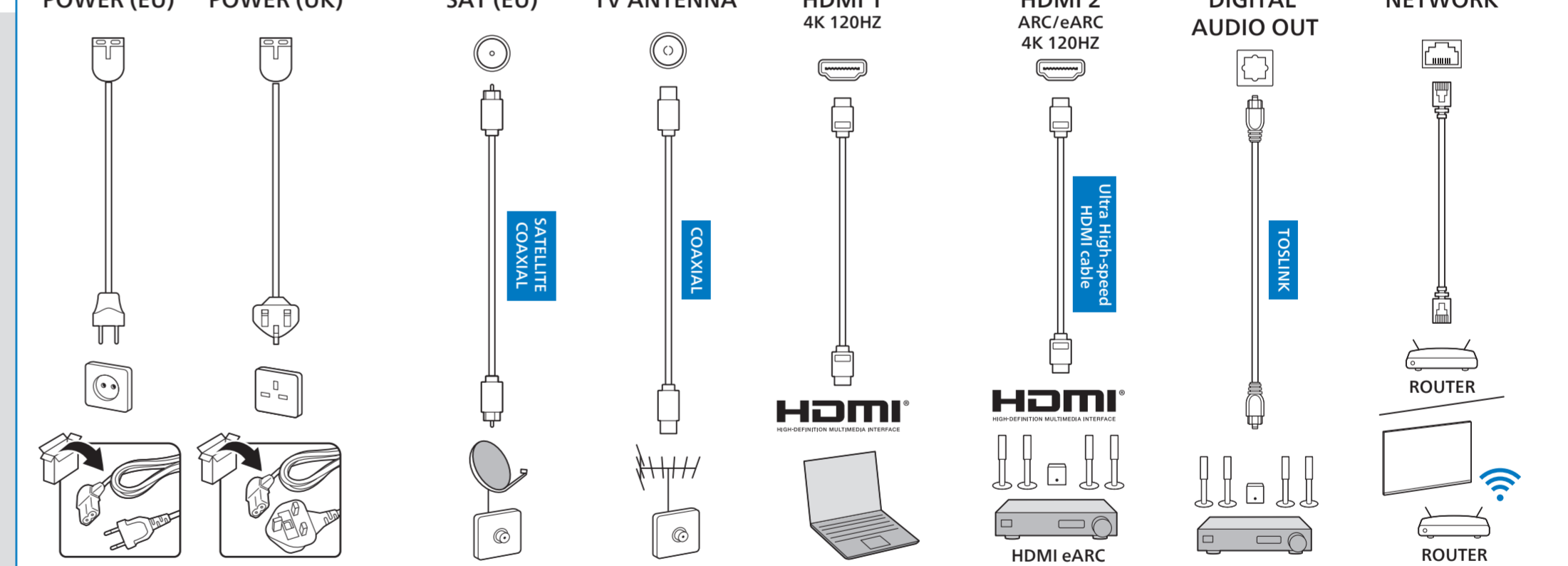
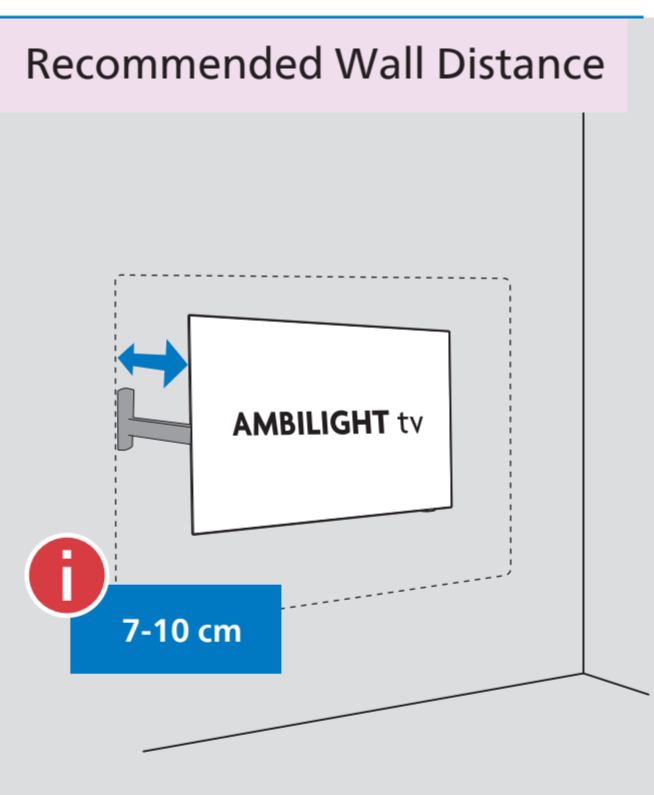

! Warning

PHILIPS

All registered and unregistered trademarks are property of their respective owners. Specifications are subject to change without notice. Philips and the Philips Shield Emblem are registered trademarks of Koninklijke Philips N.V. and are used under license. This product has been manufactured by and is sold under the responsibility of TP Vision Europe B.V., and TP Vision Europe B.V. is the warrantor in relation to this product. 2025 © TP Vision Europe B.V. All rights reserved. www.philips.com/welcome