

EW6C4723SC



EN Tumble Dryer

User Manual



CONTENTS

1. SAFETY INFORMATION.....	3
2. SAFETY INSTRUCTIONS.....	5
3. PRODUCT DESCRIPTION.....	7
4. CONTROL PANEL.....	7
5. PROGRAMME TABLE.....	8
6. OPTIONS.....	10
7. SETTINGS.....	11
8. BEFORE FIRST USE.....	12
9. DAILY USE.....	12
10. HINTS AND TIPS.....	13
11. CARE AND CLEANING.....	13
12. TROUBLESHOOTING.....	16
13. TECHNICAL DATA.....	17
14. PRODUCT INFORMATION SHEET IN REFERENCE TO E.U. REGULATION 1369/2017.....	19

WE'RE THINKING OF YOU

Thank you for purchasing an Electrolux appliance. You've chosen a product that brings with it decades of professional experience and innovation. Ingenious and stylish, it has been designed with you in mind. So whenever you use it, you can be safe in the knowledge that you'll get great results every time.

Welcome to Electrolux.

Visit our website for:



Get usage advice, brochures, trouble shooter, service information:
www.electrolux.com/webselfservice



Register your product for better service:
www.registerelectrolux.com



Buy Accessories, Consumables and Original spare parts for your appliance:
www.electrolux.com/shop

CUSTOMER CARE AND SERVICE

Always use original spare parts.

When contacting our Authorised Service Centre, ensure that you have the following data available: Model, PNC, Serial Number.

The information can be found on the rating plate.

 Warning / Caution-Safety information

 General information and tips

 Environmental information

Subject to change without notice.

1. ⚠️ SAFETY INFORMATION

Before beginning the installation and use of this appliance, carefully read the supplied instructions. The manufacturer is not responsible for any injuries or damage that are the result of incorrect installation or usage. Always keep the instructions in a safe and accessible location for future reference.

1.1 Children and vulnerable people safety



WARNING!

Risk of suffocation, injury or permanent disability.

- This appliance can be used by children aged from 8 years and above and persons with reduced physical, sensory or mental capabilities or lack of experience and knowledge if they have been given supervision or instruction concerning the use of the appliance in a safe way and understand the hazards involved.
- Children between 3 and 8 years of age and persons with very extensive and complex disabilities shall be kept away from the appliance unless continuously supervised.
- Children of less than 3 years of age should be kept away from the appliance unless continuously supervised.
- Do not let children play with the appliance.
- Keep all packaging away from children and dispose of it appropriately.
- Keep detergents away from children.
- Keep children and pets away from the appliance when the door is open.
- If the appliance has a child safety device, it should be activated.
- Children shall not carry out cleaning and user maintenance of the appliance without supervision.

1.2 General Safety

- Do not change the specification of this appliance.
- If the tumble dryer is put on top of a washing machine, use the stacking kit. The stacking kit, available from your authorized vendor, can be used only with the appliance specified in the instructions supplied with the accessory. Read it carefully before installation (refer to the Installation leaflet).
- The appliance can be installed as freestanding or below a kitchen counter with correct space (refer to the Installation leaflet).
- Do not install the appliance behind a lockable door, a sliding door or a door with a hinge on the opposite side, that would prevent the appliance door from being fully open.
- The ventilation opening in the base must not be covered by a carpet, mat, or any floor covering.
- CAUTION: The appliance must not be supplied through an external switching device, such as a timer, or connected to a circuit that is regularly switched on and off by a utility.
- Connect the mains plug to the mains socket only at the end of the installation process. Make sure that the mains plug is accessible after installation.
- If the mains power supply cable is damaged, it must be replaced by the manufacturer, its Authorised Service Centre or similarly qualified persons to avoid an electrical hazard.
- Do not exceed the maximum load of 7 kg (refer to the "Programme chart" chapter).
- Do not use the appliance if items have been soiled with industrial chemicals.
- Wipe away lint or packaging debris that has accumulated around the appliance.
- Do not run the appliance without a filter. Clean the lint filter before or after each use.
- Do not dry unwashed items in the tumble dryer.

- Items that have been soiled with substances such as cooking oil, acetone, alcohol, petrol, kerosene, spot removers, turpentine, waxes and wax removers should be washed in hot water with an extra amount of detergent before being dried in the tumble dryer.
- Items such as foam rubber (latex foam), shower caps, waterproof textiles, rubber backed articles and clothes or pillows fitted with foam rubber pads should not be dried in the tumble dryer.
- Fabric softeners, or similar products, should only be used as specified by the product manufacturer's instructions.
- Remove all objects from items that could be a source of fire ignition such as lighters or matches.
- **WARNING:** Never stop a tumble dryer before the end of the drying cycle unless all items are quickly removed and spread out so that the heat is dissipated.
- Before any maintenance operation, deactivate the appliance and disconnect the mains plug from the socket.

2. SAFETY INSTRUCTIONS

2.1 Installation

- Remove all the packaging.
- Do not install or use a damaged appliance.
- Follow the installation instructions supplied with the appliance.
- Always take care when moving the appliance as it is heavy. Always use safety gloves and enclosed footwear.
- Do not install or use the appliance where the temperature can be lower than 5°C or higher than 35°C.
- The floor area on which the appliance is to be installed must be flat, stable, heat resistant and clean.
- Make sure that there is air circulation between the appliance and the floor.
- Always keep the appliance vertical when it is being moved.
- The rear surface of the appliance must be put against a wall.

- When the appliance is in its permanent position, check if it is levelled correctly with the aid of a spirit level. If it is not, adjust the feet accordingly.

2.2 Electrical connection



WARNING!

Risk of fire and electric shock.

- The appliance must be earthed.
- Make sure that the parameters on the rating plate are compatible with the electrical ratings of the mains power supply.
- Always use a correctly installed shockproof socket.
- Do not use multi-plug adapters and extension cables.

- Do not pull the mains cable to disconnect the appliance. Always pull the mains plug.
- Do not touch the mains cable or the mains plug with wet hands.

2.3 Use



WARNING!

Risk of injury, electric shock, fire, burns or damage to the appliance.

- This appliance is for household use only.
- Do not dry damaged (torn, frayed) items that contain padding or fillings.
- If laundry has been washed with a stain remover, carry out an additional rinse cycle before starting a drying cycle.
- Dry only fabrics that are suitable to dry in the appliance. Follow the cleaning instruction on the item label.
- Do not drink or prepare food with the condensed water/distilled water. It can cause health problems to people and pets.
- Do not sit or stand on the open door of the appliance.
- Do not dry dripping wet clothes in the appliance.

2.4 Care and cleaning



WARNING!

Risk of injury or damage to the appliance.

- Do not use water spray and steam to clean the appliance.
- Clean the appliance with a moist soft cloth. Use only neutral detergents. Do not use abrasive products, abrasive cleaning pads, solvents or metal objects.

2.5 Service

- To repair the appliance contact the Authorised Service Centre.
- Use original spare parts only.

2.6 Disposal



WARNING!

Risk of injury or suffocation.

- Disconnect the appliance from the mains electrical and water supplies.
- Cut off the mains electrical cable close to the appliance and dispose of it.
- Remove the door catch to prevent children or pets from becoming trapped in the drum.
- Dispose of the appliance in accordance with local requirements for the disposal of Waste Electrical and Electronic Equipment (WEEE).

3. PRODUCT DESCRIPTION

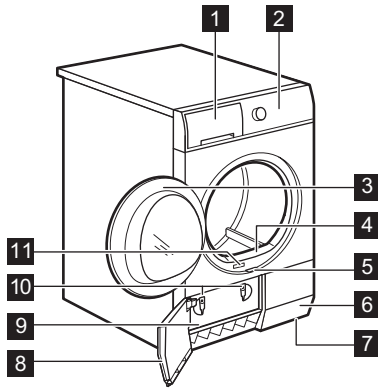

- 1** Water container
- 2** Control panel
- 3** Appliance door
- 4** Primary Filter
- 5** Button for condenser door
- 6** Airflow slots
- 7** Adjustable feet
- 8** Condenser door
- 9** Condenser cover
- 10** Locks for condenser lid
- 11** Rating plate

i For ease of loading laundry or ease of installation the door is reversible. (see separate leaflet).

4. CONTROL PANEL

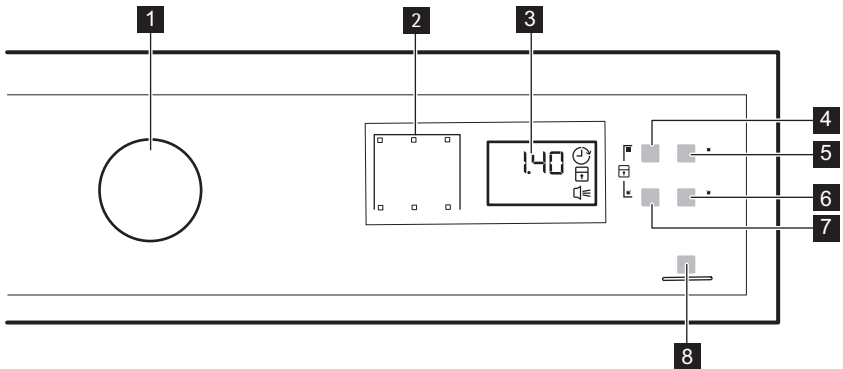

- 1** Programme knob and ⏻ OFF switch
- 2** Indicators
- 3** Display
- 4** ⌚ Minuterie touchpad
- 5** ⌚ Départ Différé touchpad
- 6** 🌸 Délicats touchpad
- 7** 🛑 Anti-froissage touchpad
- 8** ▶|| Départ/Pause touchpad



Press the touch buttons with your finger in the area with the symbol or name of the option. Do not wear gloves when you operate the control panel. Make sure that the control panel is always clean and dry.

4.1 Indicators

Indicators	Description
	Drying phase
	Cooling phase
	Crease guard phase
	Condenser
	Water container
	Filter
	Delay start
	Child lock
	Acoustic signals
2.00	Programme duration
10' - 2.00	Time Drying duration
30' - 20 h	Delay start duration

5. PROGRAMME TABLE

Programme	Load ¹⁾	Properties / Fabric type ²⁾
³⁾ Coton Eco	7 kg	Cycle to be used to dry cotton with "cotton cupboard" dryness level, with maximum energy saving. /
Coton Très sec	7 kg	Drying level: extra dry. /

Programme	Load ¹⁾	Properties / Fabric type ²⁾
Coton Prêt à Ranger	7 kg	Cycle defined to dry all types of cotton ready to store (cupboard dry). / ☺☺☐
Coton Prêt à repasser	7 kg	Drying level: suitable for ironing. / ☺☺☐
Synthétiques Très sec	3,5 kg	Drying level: extra dry. / ☺☺☺☐
Synthétiques Prêt à Ranger	3,5 kg	Drying level: cupboard dry. / ☺☺☺☐
Repassage Facile	1 kg (or 5 shirts)	Easy care fabrics for which a minimum of ironing is necessary. The drying results can be different from one type of fabric to another. Shake the items before putting them in the appliance. When the programme has ended, immediately remove the items and put them on a hanger. / ☺☺☺☐
Minuterie	5 kg	With this programme you can use the Minuterie option and set the programme duration. Drying time should be adequate to the load, e.g. 2h for 5 kg of cotton. / ☺☺☺☐
Rafraîchir	1kg	Refreshing textiles that were in storage.
Mixtes	3kg	Cotton and synthetic fabrics. Low temperature programme. Delicate programme with warm air. / ☺☺☺☐
Sport	2 kg	Sportswear, thin and light fabrics, microfiber, polyester. / ☺☺☺☐
Draps	3kg	Bed linen such as single and double sheets, pillowcases, duvet cover. / ☺☺☺☐
Denim	4 kg	Leisure clothing such as jeans, sweat-shirts of different material thicknesses (e.g. at the neck, cuffs and seams). / ☺☺☺☐

Programme	Load 1)	Properties / Fabric type ²⁾
Délicats	4 kg	Delicate fabrics such as viscose, rayon, acrylic, and their blends. / 

1) The maximum weight refers to dry items.

2) For fabric mark meaning see chapter *HINTS AND TIPS: Preparing the laundry*.

3) The  Coton Prêt à Ranger ECO programme is the “Standard cotton programme” according to Commission Regulation EU No. 392/2012. It is suitable for drying normal wet cotton laundry and it is the most efficient programme in terms of energy consumption for drying wet cotton laundry.

6. OPTIONS

6.1 Délicats

With this option you can set a delicate drying programme that has a low temperature. Use this option with a fabrics that have the symbol  on the fabric label (e.g. acrylic, viscose).

6.2 Anti-froissage

Extends the anti-crease phase by 60 minutes at the end of the drying cycle. This function reduces creases. The laundry can be removed during the anti-crease phase.





6.3 Minuterie

This option is applicable only to the Minuterie programme. You can set the programme duration, from a minimum of 10 minutes to a maximum of 2 hours. The required duration is related to the quantity of laundry in the appliance.



We recommend that you set a short duration for small quantities of laundry or for only one item.

6.4 Options table

Programmes ¹⁾	 Délicats	 Anti-froissage	 Minuterie
 Coton Eco		■	
Coton Très sec	■	■	
Coton Prêt à Ranger	■	■	
Coton Prêt à repasser	■	■	
Synthétiques Très sec	■	■	
Synthétiques Prêt à Ranger	■	■	
Repassage Facile	■	■	
Minuterie	■	■	■

Programmes ¹⁾	☼ Délicats	📄 Anti-froissage	🕒 Minuterie
Rafraîchir		■	
Mixtes		■	
Sport		■	
Draps		■	
Denim	■	■	
Délicats	■	■	

¹⁾ Together with the programme you can set 1 or more options. To activate or deactivate them, press the related touch button.

7. SETTINGS

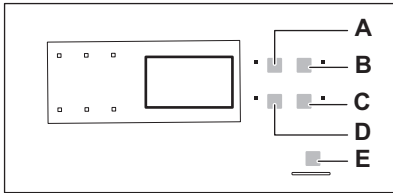

- A. Minuterie 🕒 touchpad
- B. Départ Différé ⌚ touchpad
- C. Délicats ☼ touchpad
- D. Anti-froissage 📄 touchpad
- E. Départ/Pause ▶|| touchpad

7.1 Child lock function

This option prevents children to play with the appliance while a programme operates. The programme knob and the touchpads are locked.

Only ⓪ OFF switch is unlocked.

Activating the child lock option:

1. Use the programme knob to set any programme.
2. Wait approximately 8 seconds.
3. Press and hold touchpads (A) and (D) at the same time. The child lock indicator comes on.

The child lock indicator comes on.



It is possible to deactivate the child lock option while a programme operates. Press and hold the same touchpads until the child lock indicator goes off.

7.2 Adjustment of the remaining laundry moisture degree

To change the default degree of the remaining moisture of the laundry:

1. Use the programme knob to set any programme.
2. Wait approximately 8 seconds.
3. Press and hold buttons (A) and (B) at the same time.

One of these indicators comes on:

- [0] the maximum dry laundry
 - [0] the more dry laundry
 - [0] the standard dry laundry
4. Press the button (E) again and again until the indicator of the correct level comes on.
 5. To confirm the adjustment, press and hold buttons (A) and (B) at the same time for approximately 2 seconds.

7.3 Buzzer on/off

To deactivate or activate the acoustic signals, press and hold for approximately 2 seconds touch buttons (B) and (C) at the same time.

8. BEFORE FIRST USE

Before you use the appliance to dry items:

- Clean the tumble dryer drum with a moist cloth.

9. DAILY USE

9.1 Start a programme without delay start

1. Prepare the laundry and load the appliance.



CAUTION!

Make sure that when you close the door, the laundry does not get caught between the appliance door and the rubber seal.

2. Set the correct programme and options for the type of load.

The display shows the programme duration.



Real drying time will depend on type of the load (quantity and composition), the room temperature and the humidity of your laundry after spin drying phase.

3. Press the Départ/Pause touch button.

The programme starts.

9.2 Starting the programme with delay start

1. Set the correct programme and options for the type of load.
2. Press the delay start button again and again until the display shows the delay time you want to set.



You can delay the start of a programme from a minimum of 30 minutes to a maximum of 20 hours.

3. Press the Départ/Pause touchpad. The display shows the countdown of the delay start.

- Start a 1 hour programme with moist laundry.

When the countdown is completed, the programme starts.

9.3 Change a programme

1. Turn the Programme knob to ① OFF
2. Set the programme.

9.4 At the end of the programme

When the programme is completed:

- An intermittent acoustic signal operates.
- The indicator flashes.
- The indicator flashes.
- The Départ/Pause indicator is on. The appliance continues to operate with the crease guard phase for approximately other 30 minutes.

The crease guard phase prevents creases from your laundry.

You can remove the laundry before the crease guard phase is completed. We recommend, for better results, that you remove the laundry when the phase is almost completed.

When the crease guard phase is completed:

- The indicator is on but does not flash.
- The indicator is on but does not flash.
- Départ/Pause indicator goes off.

1. Turn the Programme knob to ① OFF
2. Open the appliance door.
3. Remove the laundry.
4. Close the appliance door.

 **Always clean the filter and empty the water container when a programme is completed.**

- After 5 minutes if you do not start the programme.
- After 5 minutes from the end of the programme.





9.5 Stand-by function

To decrease the energy consumption, this function automatically deactivates the appliance:

10. HINTS AND TIPS

10.1 Preparing the laundry

- Close the zips.
- Close the fasteners of duvet covers.
- Do not dry ties or ribbons loose (e.g. apron ribbons). Tie them before you start a programme.
- Remove all items from pockets.
- Turn items with the internal layer made of cotton inside out. Cotton layer must be faced outwards.
- Always set the programme suitable for the type of laundry.
- Do not put light and dark colours together.
- Use suitable programme for cottons, jersey and knitwear to reduce shrinkage.
- Do not exceed the maximum load stated in the programmes chapter or shown on the display.
- Dry only the laundry that is suitable for tumble drying. Refer to the fabric label on the items.
- Do not dry large and small items together. Small items can be trapped inside the large items and remain wet.

Fabric label	Description
	Laundry is suitable for tumble drying.
	Laundry is suitable for tumble drying at higher temperatures.
	Laundry is suitable for tumble drying at low temperatures only.
	Laundry is not suitable for tumble drying.

11. CARE AND CLEANING

11.1 Cleaning the filter



CAUTION!

Avoid the use of water to clean the filter. Instead throw away lint in the dustbin (avoid dispersion of plastic fiber in water ambient).



To achieve the best drying performances clean the filter regularly , clogged filter lead to longer cycles and energy consumption increase. Use your hand to clean the filter , and if necessary , a vacuum cleaner .

1.

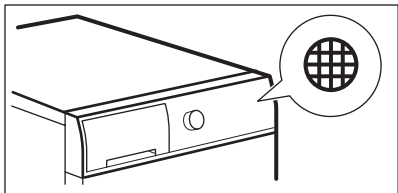

2.

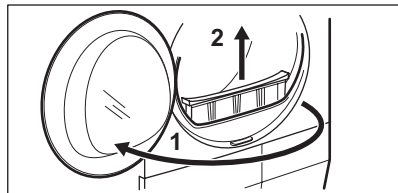

3.

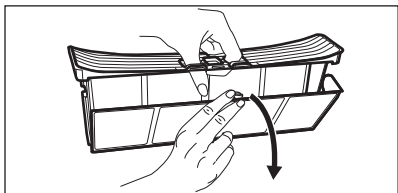

4.



5.

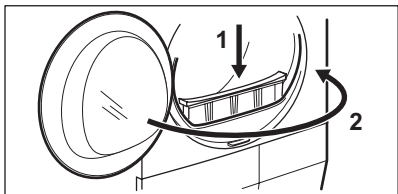

11.2 Emptying the water container

1.

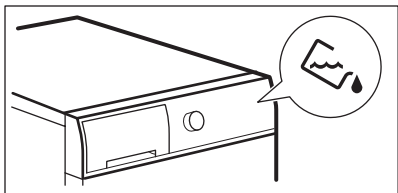

2.

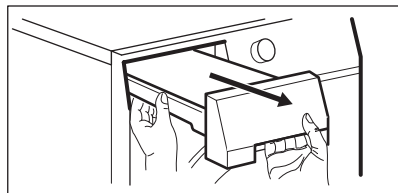

3.

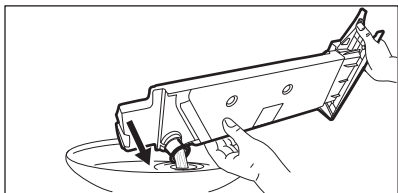

4.

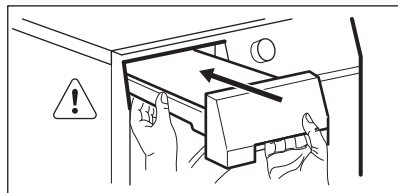

i You can use the water from the water container as an alternative to distilled water (e.g. for steam ironing). Before you use the water, remove dirt residues with a filter.

11.3 Cleaning the condenser

1.

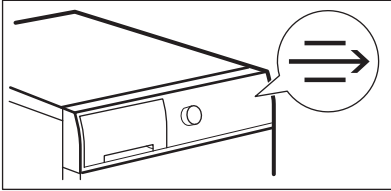

2.

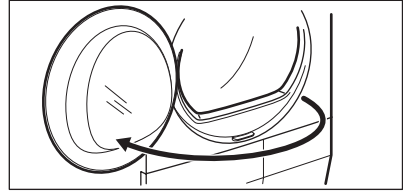

3.

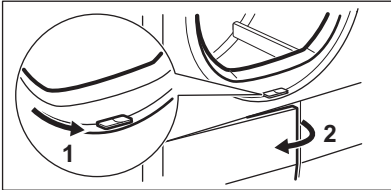

4.

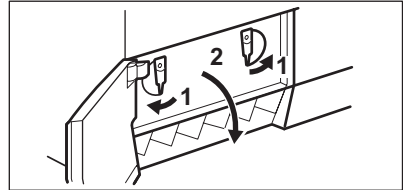

5.

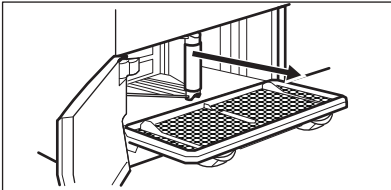

6.

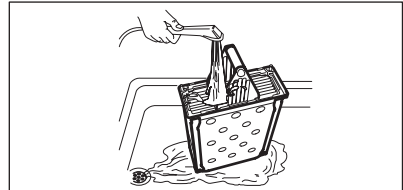

7.

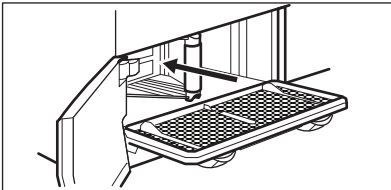

8.

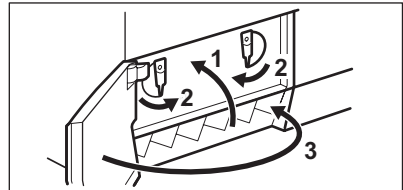

11.4 Cleaning the drum

! **WARNING!**
Disconnect the appliance before you clean it.

Use a standard neutral soap detergent to clean the inner surface of the drum and

drum lifters. Dry the cleaned surfaces with a soft cloth.

! **CAUTION!**
Do not use abrasive materials or steel wool to clean the drum.

11.5 Cleaning the control panel and housing

Use a standard neutral soap detergent to clean the control panel and housing.

Use a moist cloth to clean. Dry the cleaned surfaces with a soft cloth.



CAUTION!

Do not use furniture cleaning agents or cleaning agents which can cause corrosion.

11.6 Cleaning the airflow slots

Use a vacuum cleaner to remove fluff from the airflow slots.

12. TROUBLESHOOTING

Problem	Possible solution
You cannot activate the appliance.	Make sure that the mains plug is connected to the mains socket.
	Check fuse in fuse box (domestic installation).
The programme does not start.	Press Départ/Pause.
	Make sure that the appliance door is closed.
The appliance door does not close.	Make sure that the installation of the filter is correct.
	Make sure that the laundry does not catch between the appliance door and the rubber seal.
The appliance stops during operation.	Make sure that the water container is empty. Press Départ/Pause to start the programme again.
The cycle time is too long or unsatisfactory drying result. ¹⁾	Make sure that the weight of the laundry is applicable to the duration of the programme.
	Make sure that the filter is clean.
	The laundry is too wet. Spin the laundry in the washing machine again.
	Ensure that the room temperature is higher than +5°C and lower than +35°C. Optimal room temperature is 19°C to 24°C.
	Set the Minuterie or the Très sec programme. ²⁾

Problem	Possible solution
The display shows Err.	If you want to set a new programme, deactivate and activate the appliance.
	Make sure that the options are applicable to the programme.
The display shows (e.g. E51).	Deactivate and activate the appliance. Start a new programme. If the problem occurs again, contact the Service.

1) After maximum 5 hours, the programme ends automatically.

2) It can happen that some area remains humid when drying big items (e.g. bed sheets).

If the drying results are not satisfactory

- The set programme was incorrect.
- The filter is clogged.
- The condenser is clogged.
- There was too much laundry in the appliance.
- The drum is dirty.
- Incorrect setting of the conductivity sensor (See chapter "*Settings* -

Adjustment of the remaining laundry moisture degree" for better setting).

- The airflow slots are clogged.
- Room temperature is too low or too high (optimal room temperature 19°C to 24°C)

13. TECHNICAL DATA

Height x Width x Depth	850 x 596 x 570 mm (maximal 594 mm)
Max. depth with the appliance door open	1039 mm
Max. width with the appliance door open	958 mm
Adjustable height	850 mm (+ 15 mm - feet regulation)
Drum volume	104 l
Maximum load volume	7 kg
Voltage	230 V
Frequency	50 Hz
Sound power level	66 dB
Total power	2800 W
Energy efficiency class	B
Energy consumption on the standard cotton programme with the full load. ¹⁾	4,23 kWh
Energy consumption on the standard cotton programme with the partial load. ²⁾	2,29 kWh

Annual energy consumption ³⁾	503,50 kWh
Left-on mode power absorption ⁴⁾	0,50 W
Off mode power absorption ⁴⁾	0,50 W
Type of use	Household
Allowed ambient temperature	+ 5°C to + 35°C
Level of protection against ingress of solid particles and moisture ensured by the protective cover, except where the low voltage equipment has no protection against moisture	IPX4

1) With reference to EN 61121. 7 kg of cotton centrifuged at 1000 rpm.

2) With reference to EN 61121. 3,5 kg of cotton centrifuged at 1000 rpm.

3) Energy consumption per year in kWh, based on 160 drying cycles of the standard cotton programme at full and partial load, and the consumption of the low-power modes. Actual energy consumption per cycle will depend on how the appliance is used (REGULATION (EU) No. 392/2012).

4) With reference to EN 61121.

The information given in the chart above is compliant with the EU Commission regulation 392/2012 implementing directive 2009/125/EC.

13.1 Consumption data

Programme	Spun at / residual humidity	Drying time ¹⁾	Energy consumption ²⁾
Coton Eco 7 kg			
Prêt à Ranger	1400 rpm / 50%	111 min.	3,63 kWh
	1000 rpm / 60%	129 min.	4,23 kWh
Coton 7 kg			
Prêt à repasser	1400 rpm / 50%	79 min.	2,71 kWh
	1000 rpm / 60%	98 min.	3,36 kWh
Coton Eco 3,5 kg			
Prêt à Ranger	1400 rpm / 50%	62 min.	1,96 kWh
	1000 rpm / 60%	72 min.	2,29 kWh
Synthétiques 3,5 kg			
Prêt à Ranger	1200 rpm / 40%	55 min.	1,56 kWh

Programme	Spun at / residual humidity	Drying time ¹⁾	Energy consumption ²⁾
	800 rpm / 50%	67 min.	1,90 kWh

1) For partial loads, the cycle time is shorter and appliance uses less energy.

2) Improper ambient temperature and/or poorly centrifuged laundry can prolong cycle time and increase the energy consumption.

14. PRODUCT INFORMATION SHEET IN REFERENCE TO E.U. REGULATION 1369/2017

Product Information Sheet	
Trade Mark	Electrolux
Model	EW6C4723SC
Rated capacity in kg	7
Air vented or condenser tumble dryer	Condenser
Energy efficiency class	B
Energy consumption in kWh per year, based on 160 drying cycles of the standard cotton programme at full and partial load, and the consumption of the low-power modes. Actual energy consumption per cycle will depend on how the appliance is used.	503,50
Automatic tumble drier or non-automatic tumble drier	Automatic
Energy consumption of the standard cotton programme at full load in kWh	4,23
Energy consumption of the standard cotton programme at partial load in kWh	2,29
Power consumption of the off-mode in W	0,50
Power consumption in left-on mode in W	0,50
Duration of the left on mode in minutes	10
The 'standard cotton programme' used at full and partial load is the standard drying programme to which the information in the label and the fiche relates, this programme is suitable for drying normal wet cotton laundry and it is the most efficient programme in terms of energy consumption for cotton.	
Weighted programme time of the 'standard cotton programme at full and partial load' in minutes	96
Programme time of the 'standard cotton programme at full load' in minutes	129

Programme time of the 'standard cotton programme at partial load' in minutes	72
Condensation efficiency class on a scale from G (least efficient) to A (most efficient)	B
Average condensation efficiency of the standard cotton programme at full load as a percentage	81
Average condensation efficiency of the standard cotton programme at partial load as a percentage	81
Weighted condensation efficiency for the 'standard cotton programme at full and partial load'	81
Sound power level in dB	66
Built in appliance Y/N	No

The information given in the chart above is compliant with the EU Commission regulation 392/2012 implementing directive 2009/125/EC.

15. ENVIRONMENTAL CONCERNS

Recycle materials with the symbol . Put the packaging in relevant containers to recycle it. Help protect the environment and human health by recycling waste of electrical and electronic appliances. Do not dispose of

appliances marked with the symbol  with the household waste. Return the product to your local recycling facility or contact your municipal office.

www.electrolux.com/shop



136958851-A-402019

